

Stempel | 1 Anfrage Bestellung

Absender:

Max Hering KG

Schütte-Lanz-Str. 7a
26135 Oldenburg

Tel. 0441 20 68 2-0

Fax 0441 20 68 2-22

info@max-hering.de

max-hering.de

max-hering.werbeland-partner.com

barrierefreie-schilder.de

Telefon (bitte immer angeben): _____

Gewünschter Liefertermin: _____

Bei Ihrer Bestellung bitten wir folgende Angaben zu beachten:

- Ohne Angaben zu Schrift- oder Satzmuster wird grundsätzlich Helvetica als Standardschrift verwendet.
- Sollten zusätzlich keine Schriftgrößen angegeben sein, wird der Stempel optisch bis 6x3 cm gefertigt.

Text:

1. Zeile _____

2. Zeile _____

3. Zeile _____

4. Zeile _____

5. Zeile _____

6. Zeile _____

7. Zeile _____

8. Zeile _____

Stempelart:

Anz. Format | Kissenfarbe

Holzstempel _____

Selbstfärber _____

Printy _____

Satzanordnung:

<input type="checkbox"/> linksbündig	<input type="checkbox"/> zentriert	<input type="checkbox"/> rechtsbündig	<input type="checkbox"/> Blocksatz
Eveline Hansen Krankenschwester Jagdweg 14 26543 Oldenburg	Eveline Hansen Krankenschwester Jagdweg 14 26543 Oldenburg	Eveline Hansen Krankenschwester Jagdweg 14 26543 Oldenburg	Eveline Hansen Krankenschwester Jagdweg 14 26543 Oldenburg

Stempel | 2

Schriftmuster: _____

- | | | |
|--------------------------------|-------------------------------------|--------------------------------|
| 1 <i>Apple Chancery</i> | 12 <i>Englische Schreibschrift</i> | 23 Revue D |
| 2 <i>Aristus D</i> | 13 Futura T Medium | 24 Roctus T |
| 3 Avant Garde Book | 14 Handel Gothic | 25 Taffy |
| 4 BANK GOTHIC | 15 Helvetica Condensed | 26 Times Script |
| 5 Bauhaus Medium | 16 Helvetica light | 27 Times New Roman |
| 6 Benguiat Book | 17 Helvetica roman | 28 <i>Times Italic</i> |
| 7 <i>Brush Script</i> | 18 Helvetica Bold | 29 Triplex Bold |
| 8 <i>caflisch Script Bold</i> | 19 Hobo Std | 30 <i>Triplex Bold Italic</i> |
| 9 Comic Sans MS | 20 META-CAPS | 31 VAG Rounded Bold |
| 10 COPPERPLATE | 21 <i>Murray Hill D</i> | 32 <i>Van Dijk D</i> |
| 11 Crille T | 22 PEIGNOT DEMI | 33 <i>Zapf Chancery</i> |

Andere Schrift: _____

Lagerstempel: _____

- | | |
|--|--------------------------------|
| 1 Abschrift | 14 G e p r ü f t |
| 2 Betrag dankend erhalten | 15 Gutschrift |
| 3 Betrag dankend erhalten
....., den | 16 Infobrief |
| 4 Bezahlt | 17 Infopost |
| 5 Büchersendung | 18 K o p i e |
| 6 Duplikat | 19 Lieferschein |
| 7 Eilt | 20 Maxibrief |
| 8 Eilt sehr | 21 Muster |
| 9 Einschreiben | 22 Nur zur Verrechnung |
| 10 Entwertet | 23 Original |
| 11 Entwurf | 24 Päckchen |
| 12 Erledigt | 25 Postgut |
| 13 Gebucht | 26 Rechnung |

Stempel | 3

Stempelmuster: _____

- 1| **DR. HORST JANSSEN**
FRAUENFACHARZT
OSTERKAMPSWEG 248
80357 MÜNCHEN
- 2| **Brigitte Kemmerle**
Gutenbergstraße 7
60534 Obertshausen
Tel.: 061 04 / 4329
- 3| **Franz Hermeling**
Kleine Straße 5 - 6
44788 Münster (Westf.)
Telefon 0251 / 32033
- 4| *Dr. Hasso von Zitzewitz*
Rechtsanwalt und Notar
Schloßweg 20 - Tel. 089 / 30 38 44
82468 München
Postbankkonto München 3344 62 - 807
- 5| Tabak - Großhandlung
Kurt Schumacher KG
Bremer Straße 30
32435 Hannover
Tel. 0511 / 13426
- 6| **Teusner & Lammers**
Autoklempnerei und Kühlerbau
Heidschnuckenweg 1
66845 Landsweiler-Reden
- 7| *Lulu's Boutique*
Lulu Rodier
Dornstraße 130
28798 Hude
- 8| *Kai Heinersdorfer*
Töpferei
Bremer Straße 235
26926 Oldenburg
- 9| **Georg Schwarting**
Reifen-Vertretung
Dürerstraße 19
26275 Emden
- 10| Corinna Lübbling
Kunsthandlung
Barbarossastraße 206
28765 Bremen
- 11| **Annette's Salon**
Damensalon
Oldenburger Straße 220
44622 Nordhorn
- 12| **Auto Bigalke**
Autohaus
Huntemannstraße 200
26954 Nordenhamm
E-Mail: auto.bigalke@t-online.de
- 13| *Karl - Heinz Wintermann*
Installateurmeister
Tweelbäker Tredde 47 - Tel.: 04 41 / 43 89
63502 Bad Nauheim
- 14| **Betonwerk Lux**
Industriestraße 1-2
62483 Wiesbaden
Telefon 061 21 / 23 80 28
Telefax 061 21 / 23 80 28
- 15| *Horst Altmeyer*
Urwaldstraße 15
Telefon 04452 / 220
29343 Neuenburg
- 16| *Café Wachtendorf*
Inh. Brigitte Niemann
Hindenburgstr. 12
60814 Crumstadt
- 17| **HEINRICH BANNMÜLLER**
Mediengestalter
BREMER STRASSE 20
28790 SCHWANEWEDDE
- 18| **Bäckerei Kock**
Hornstr. 12
85432 Nürnberg
Tel. 09 101 / 21 31 27
- 19| *Eveline Hansen*
Krankenschwester
Jagdweg 14
26543 Oldenburg
- 20| *Dietmar Biermann*
Handelsvertreter
Dachsweg 6, Tel. 04 41 73 45 89
49002 Heidelberg
- 21| **Berngard Böse**
Zeugstraße 8
26725 Obenstrohe
- 22| **Katja Gloystein**
Große Straße 60
30906 Verden / Aller
- 23| **Irma Wintermann**
Feldweg 20
29623 Aurich
- 24| *Dr. Lila Joran*
Peterstraße 26
63036 Gießen
- 25| **Dr. Paul Kuck**
Salbeistr. 7
65277 Worms
- 26| **Irma Kehse**
Taubenstr. 24
85012 Neuhof
- 27| *Christine Laube*
Sandberg 50
83924 Passau
- 28| **Rommy Schneider**
Achterdiek
26078 Oldenburg
- 29| **HORST CORDES**
KENNEDYSTR. 5
22767 HAMNURG
- 30| **Lilly Havekost**
Gartenstraße 10
70384 Stuttgart

Stempel | 4

PROFESSIONAL LINE

Datumstempel: _____

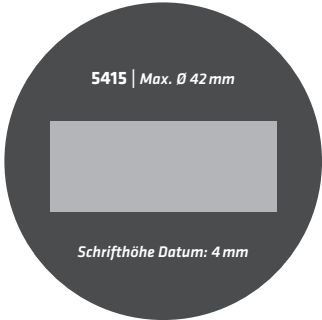
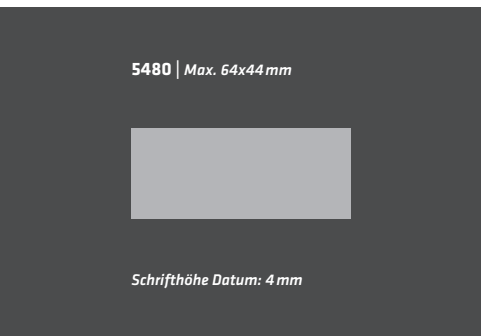
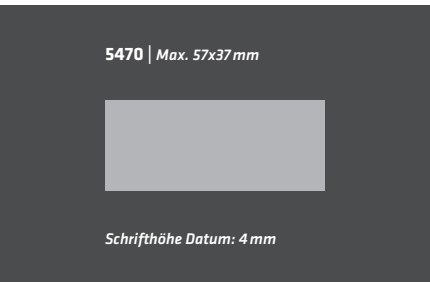
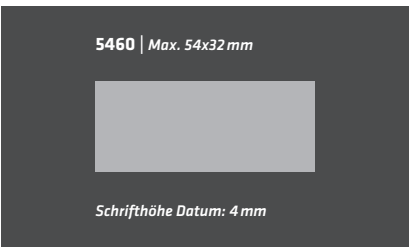
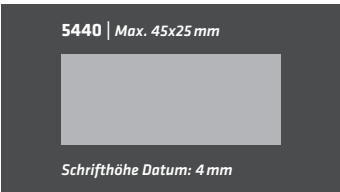
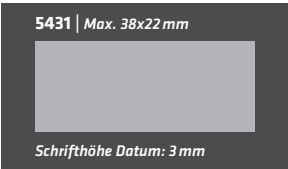
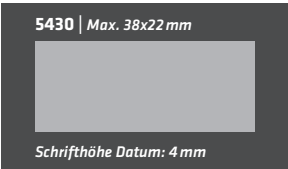

Textstempel: _____

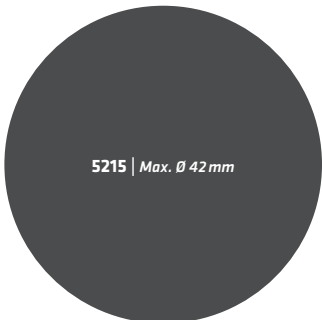
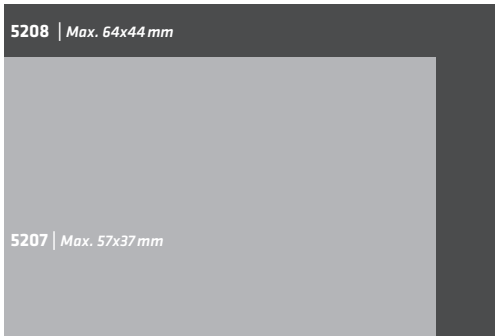
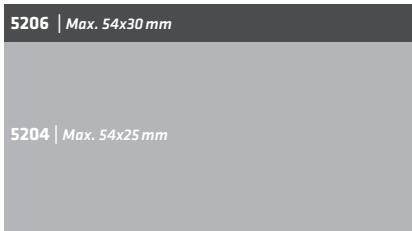
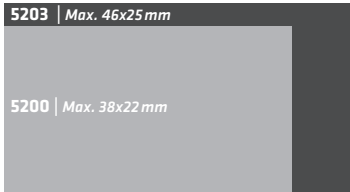

Stempel | 5

PRINTY LINE

Textstempel: _____

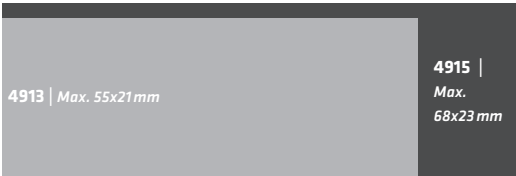

4921 | Max. 11x11 mm

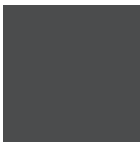

4922 | Max. 18x18 mm

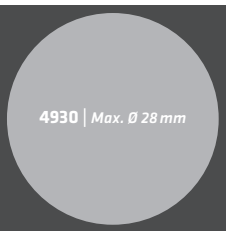

4923 | Max. Ø 28 mm

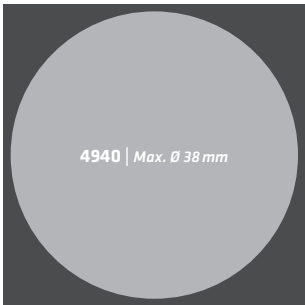

4924 | Max. Ø 38 mm

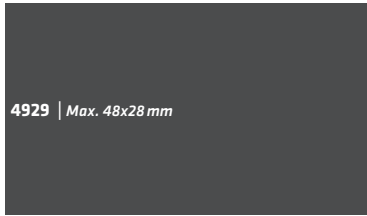
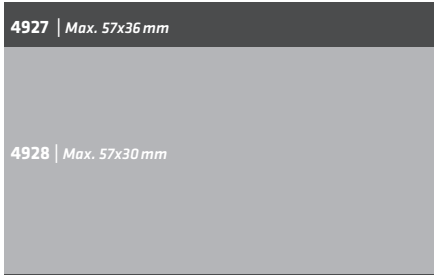
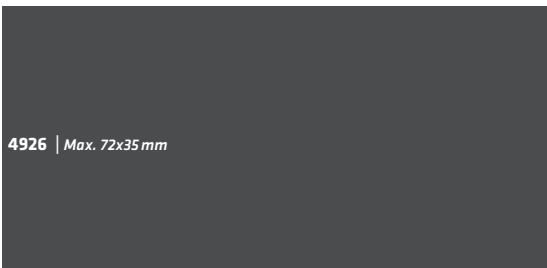

Datumstempel: _____

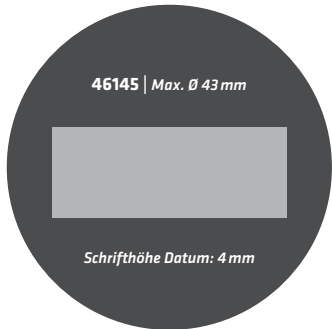
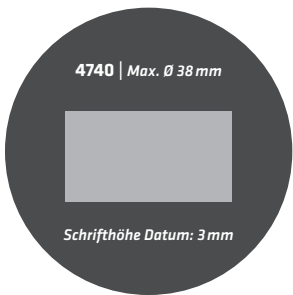
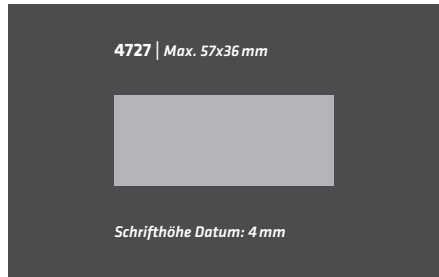
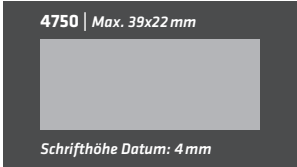
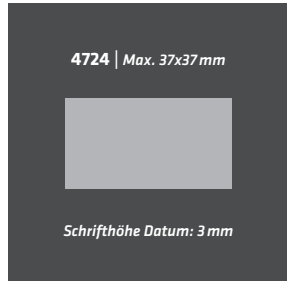

Stempel | 6

Rund - und Ovalstempel: _____

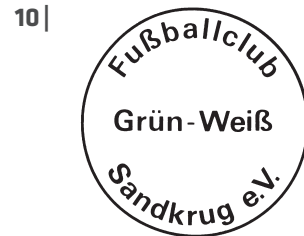
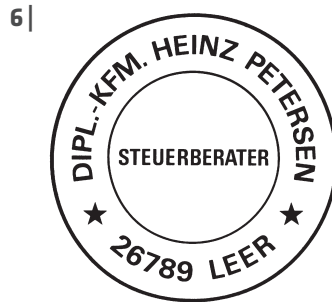
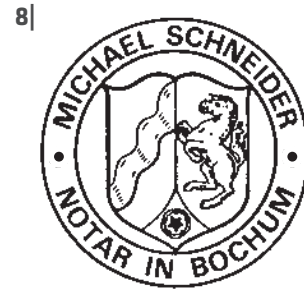

Anmerkungen
Sonstiges:
